

N

Les monteringsanvisningen nøye. Tapp av kjølevæskene. Demonter den angitte frostpluggen, i henhold til tabell. OBS! Se om din biltype er nevnt under spesielle mont.tips. Rengjør hullet godt. Plug in kontakten skal peke i henhold til tabell. Varmeren monteres ved å skru mutteren på festeskinnen helt ut, og tre festeskinnen inn samtidig som varmeren entres i hullet(I). Mutteren/bolten trekkes til med 6.0NM. Kontroller at pakningen tetter ordentlig og at varmeren ikke kan trekkes ut/evt. løsner. Forurenset/gammel kjølevæskemå byttes. Varmeren må IKKE kobles til strøm før kjølevæske, spesifisert av bilfabrikanten, er påfylt. Luft kjølesystemet i henhold til bilproduzentens anbefalinger. Apparatinntak for tilkobling av motorvarmer, må innkjøpes sammen med varmeren, så sant dette ikke forefinnes. **DEFA's nye apparatinntak; se egen anvisning. ADVARSEL:** Motorvarmeren må bare tilkobles jordet stikkontakt. Det må kontrolleres at det finnes jordingsforbindelse fra det jordete vegguttaket og helt fram til motorvarmerens kapsling, og at kjøretøyets karosseri er forbundet med beskyttelses-jordingen. Tilkoblingsledningen må behandles med forsiktighet slik at den ikke skades av f.eks. dører, panserlukk el.l., og slik at skarpe gjenstander ikke trykker på ledningen så isolasjonen skades. DEFA fraskriver seg ethvert erstatningsansvar der modifikasjon er utført og/eller varmeren ikke er montert iflg. monteringsanvisningen **REKLAMASJONSAVTALE!** Iflg. kjøpsloven. Ta vare på kvitteringen.

S

Läs noga igenom mont. anvisningen. Tappa ur kylarvätskan. Demontera den angivna frostpluggen enligt tabellen. OBS! Se om din biltyp är nämnd under speciella monterings tips. Rengör hålet noga. Plug-in kontakten skall riktas enl. tabellen. Värmaren monteras genom att skruva muttern helt ut. För in fästskenan samtidigt som värmaren placeras i frosthålet(I). Ådragningsmoment för mutter/bult är 6.0NM. Kontrollera att pakningen tätar ordentligt, samt drag i värmaren och kontrollera att den inte lossnar/glappar. Förorenat/gammal frostvätska måste bytas. Värmaren skall inte anslutas till el. uttaget innan kylarvätska är påfylt. Lufta kylsystemet enl. bilfabrikantens anvisningar; även ny kylarvätska och blandnings förhållandet (vatten/glykol) skall vara enl. bilfabrikantens anvisningar/specifikationer. Anslutningsatts för anslutning av motorvärmaren skall inhandlas samtidigt med värmaren, om den inte redan är vidpackad. **DEFA's nya intagskabel; se separat anvisning. VARNING!** Motorvärmaren får endast anslutas till jordat uttag. Det skall kontrolleras att det finns jordförbindelse från vägguttaket helt fram till värmarens kapsling, samt att fordonets kaross har kontakt med skyddsjordslingan. Anslutningskabeln måste behandlas med försiktighet så den inte blir skadad av dörrar, motorhuv el. dyl. Ej heller att skarpa kanter/hörn trycker mot kabeln så att isolationen blir skadad. DEFA fräntar sig allt ersättningsansvar där värmaren blivit modifierad och/eller värmaren inte är monterad enligt monteringsanvisningen.

REKLAMATION!

Enl. konsumentlag, vid uppvisat kvitto.

FIN

Use assembly instructions before assembly. Remove the frost plug. Remove the frost plug, as indicated in the table. OBS! Check if your car model is mentioned under special fitting tips. Clean the hole properly. Insert the heater into the hole (I). Tighten the nut/bolt together with the heater at the same time. Torque the nut/bolt to 6.0NM. Check that the gasket is completely watertight and make sure that the heater cannot loosen or be pulled out. Old or polluted coolant must be replaced. The heater must not be connected up to the power supply before coolant specified by the car manufacturer, has been filled. Bleed the cooling system in accordance with the car manufacturer's instruction book. The power cable and socket installation for connection to the heater must be purchased together with the heater if this is not already installed on the vehicle. **DEFA's new input socket, see enclosed fitting instruction. WARNING!** The engine heater must only be connected to an earthed socket. Check that there is a proper earth connection from the earthed wall socket right up to the engine heater casing and that the bodywork of the vehicle is properly connected to the protective earthing lead. Care must be taken to ensure that the heater connector lead cannot be damaged by e.g. doors, bonnet lid, etc. and the lead must not be allowed to chafe against sharp objects which could damage the insulation. DEFA cannot be held responsible for any modifications made to the installation, or for heaters which have not been installed in accordance with the fitting instructions. **IN THE CASE OF CLAIMS,** please retain your purchase receipt.

GB

Read the fitting instructions carefully. Drain off the coolant. Remove the frost plug, referring to the table. NB! Check to see if your particular model is mentioned under «special fitting tips». Refer to table to establish the correct angle for the plug-in connector. Clean the plug hole thoroughly. To fit the heater, unscrew the nut on the assembly bar and insert the assembly bar, simultaneously locating the heater in the aperture(I). Torque down the nut/bolt to 6.0NM. Check that the gasket is completely watertight and make sure that the heater cannot loosen or be pulled out. Old or polluted coolant must be replaced. The heater must not be connected up to the power supply before coolant specified by the car manufacturer, has been filled. Bleed the cooling system in accordance with the car manufacturer's instruction book. The power cable and socket installation for connection to the heater must be purchased together with the heater if this is not already installed on the vehicle. **DEFA's new input socket, see enclosed fitting instruction. WARNING!** The engine heater must only be connected to an earthed socket. Check that there is a proper earth connection from the earthed wall socket right up to the engine heater casing and that the bodywork of the vehicle is properly connected to the protective earthing lead. Care must be taken to ensure that the heater connector lead cannot be damaged by e.g. doors, bonnet lid, etc. and the lead must not be allowed to chafe against sharp objects which could damage the insulation. DEFA cannot be held responsible for any modifications made to the installation, or for heaters which have not been installed in accordance with the fitting instructions.

IN THE CASE OF CLAIMS, please retain your purchase receipt.

D

Die Montageanleitung genau durchlesen. Kühlflüssigkeit ablassen. Das angegebene Abdeckteil für das Frostloch, wie in der Tabelle bezeichnet, ausmontieren. BEACHTEN: Vergewissern Sie sich, ob ihr Fahrzeugtyp unter den besonderen Montagetips aufgeführt ist. Das Loch gut reinigen. Der Anschlussstecker soll in die Richtung zeigen, wie in der Tabelle bezeichnet. Zur Montage des Vorwärmers die Mutter an der Schiene ganz ausschrauben und die Schiene zur gleichen Zeit hineindrehen wie auch der Vorwärmer in das Loch eingesetzt wird(I). Die Mutter/den Bolzen mit 6.0NM anziehen. Kontrollieren, ob die Dichtung richtig dichtet und der Vorwärmer nicht herausgezogen werden kann oder sich eventuell löst. Verschmutzte/alte Kühlflüssigkeit muss ausgetauscht werden. Das Vorwärmergerät darf NICHT vor Einfüllen der Kühlflüssigkeit, bei den Anweisungen des Fahrzeugstellers, an den Strom angeschlossen werden. Das Kühlsystem gemäß den Anweisungen des Fahrzeugstellers entlüften. Der Stecker für den Anschluss des Motorvorwärmers muß zusammen mit dem Vorwärmer gekauft werden, falls er nicht schon beiliegt. **Der neuer Anschluss-stecker des DEFAs, siehe separat Montageanleitung. WARNUNG!** Den Motorvorwärmer nur an geerdeten El.Kontakt (Wandanschluss) anschließen. Überprüfen, daß Erdungsverbinding zwischen dem geerdeten Wandanschluss und ganz bis zur Kapsel des Motorvorwärmers besteht, und daß die Fahrzeugkarosserie mit Vorsicht behandeln, damit sie nicht z.B. durch Türen, Motorhaube oder ähnliches beschädigt wird, oder scharfe Gegenstände auf die Leitung drücken und die Isolierung beschädigt wird. In Fällen, in denen Schäden entstanden, nachdem Veränderungen an der Motorheizung durchgeführt wurden und/oder die Heizung nicht gemäß der Montageanleitung montiert wurde, lehnt DEFA jeglichen Anspruch auf Erstattung ab.

REKLAMATIONSVEREINBARUNG!

Gemäß geltender Vorschriften. Quittung aufbewahren.

I

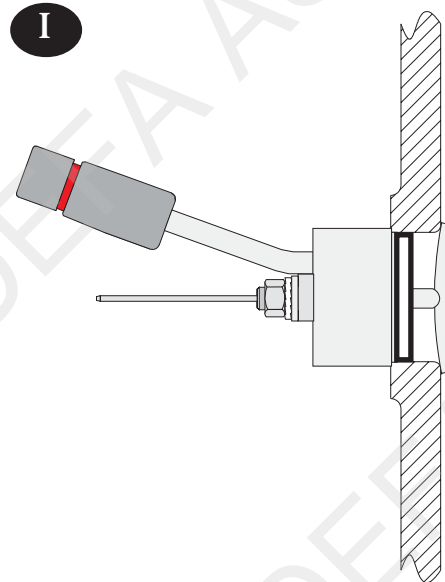





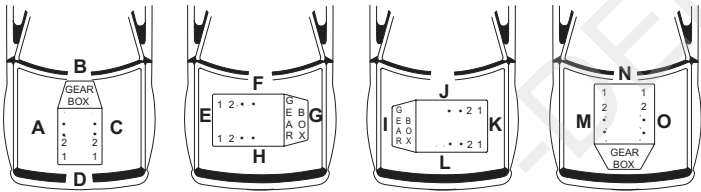

338

DEFA



MERCEDES TRAVEGO



   MS   					
MERCEDES					
TRAVEGO	01>	372	O	3	3

